

Freestanding

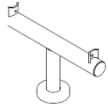

Surface Mount

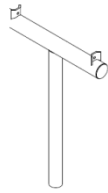

Embedded

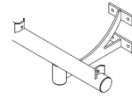

Wall Mount

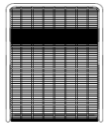

Straight Backed

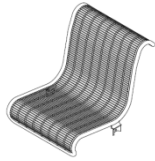

Straight Backless

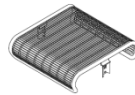

Backed Arm

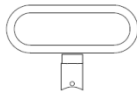

Backless Arm

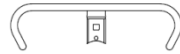

Backless Seat Side View



Table Side View

Included components:

- 7/16-20 x 1-1/2" hex head cap screw (2 per seat)
- 7/16-20 hex finish nut (2 per seat)

All hardware is stainless steel with lubricating and locking thread patch.

Tools required:

- 5/8" socket with flex head handle
- 11/16" box wrench

Anchoring hardware: Not included. Corrosion-resistant hardware is recommended. Maximum 3/8" diameter bolts recommended.

For Surface Mount: Each support has (6) 9/16" diameter holes for anchoring.

For Wall Mount: Each support has (8) 9/16" diameter holes for anchoring.

ASSEMBLE WITH CARE! Pangard II® Polyester Powdercoat is a strong, long-lasting finish. To protect this finish during assembly, place unwrapped powdercoated parts on packaging foam or other non-marring surface. Do not place or slide powdercoated parts on concrete or other hard or textured surface – this will damage the finish causing rust to occur. Use touch-up paint on any gouges in the finish caused by assembly tools.

Freestanding Installation:

1. Set unit in place.
2. Adjust glides as necessary to level bench.

Freestanding with Couplers Installation:

Coupling hardware is included. (2) 1/2-13 x 1-1/2" hex head bolts and (2) 1/2-13 hex nylock nuts are included with each support. Tools required: 3/4" wrenches.

1. Set units in place. Horizontal support tubes should be aligned and butted end-to-end. Units with couplers have 5/8" diameter holes on the ends of the supports, with access notches on the underside of the support.
2. Install hex head bolt through holes of both supports. Secure with hex nut. See Fig. 3.

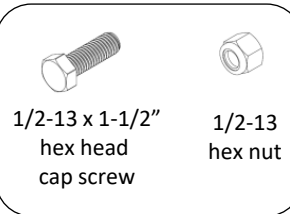

Fig. 1 – Coupling hardware

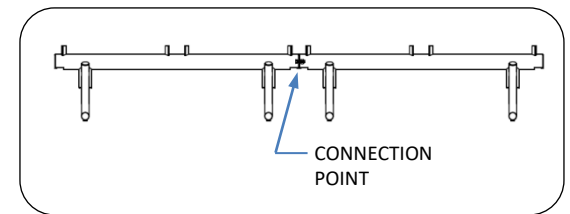

Fig. 2 – Coupling location

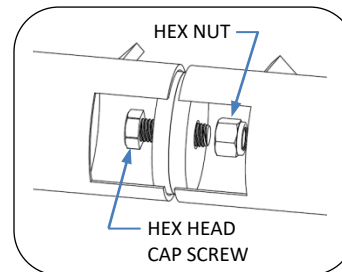

Fig. 3 – Coupling connection

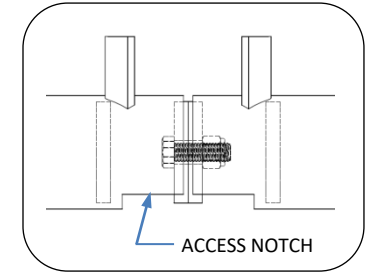

Fig. 4 – Coupling hardware installed

Surface Mount or Wall Mount Installation:

1. Set unit in place. Place all units that are to be installed in a group before anchoring any of them. Horizontal support tubes may be aligned and butted end-to-end.
2. Mark hole locations. See Fig. 5 for surface mount plate details. See Figs. 6, 7 and 8 for wall mount details.
3. Move unit to allow access for drilling holes.
4. Drill holes at marked locations according to anchor manufacturer's recommendations. Minimum 2-1/2" anchor depth is recommended.
5. Move unit back into place and install anchors.

Embedded Installation:

1. Set unit in place.
2. Mark hole locations.
3. Move unit to allow access for excavating holes.
4. Excavate area for each vertical support as shown in Fig. 9.
5. Set unit in place and secure before pouring concrete. Clean any excess concrete off of support tube.

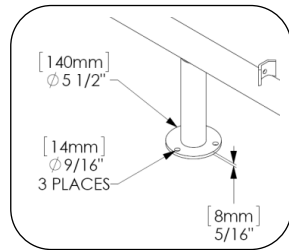

Fig. 5 – Surface Mount

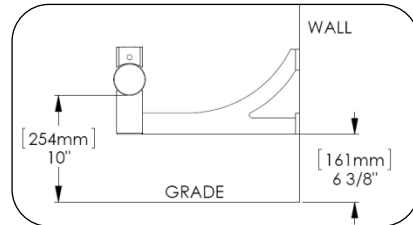

Fig. 6 – Wall Mount Up for backed seats

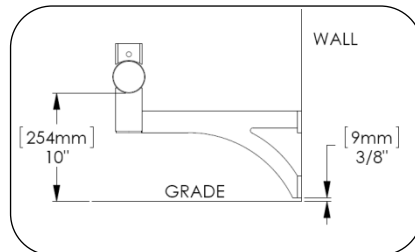

Fig. 7 – Wall Mount Down for backless seats

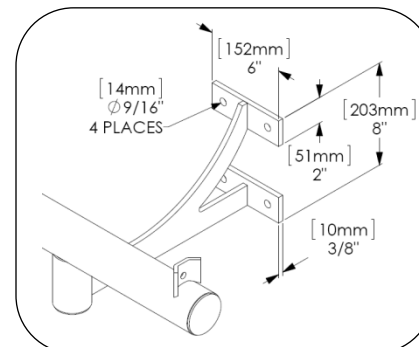

Fig. 8 – Wall mount bracket detail

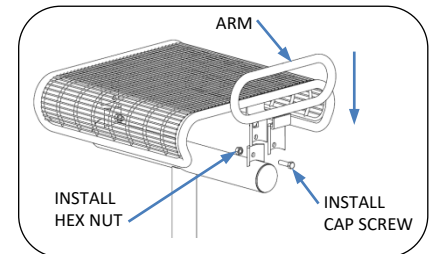

Fig. 11 – Seat install – with arm

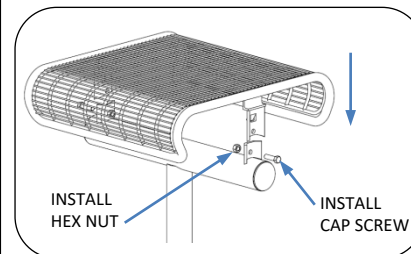

Fig. 10– Seat install – no arm

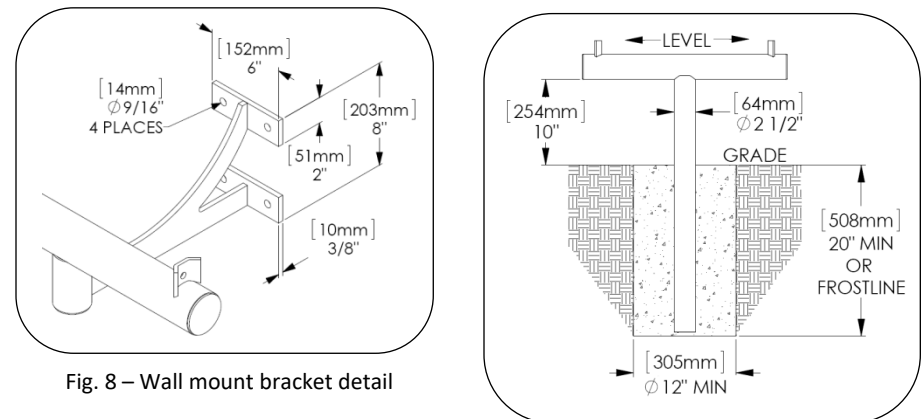

Fig. 9 – Embedded