



landscapeforms®

Backdrop Ideas and Inspirations

Backdrop is an innovative system of modular panels, posts, and accessories that presents a new solution for defining and activating a wide range of outdoor destinations. Elegantly framing spaces, providing privacy, guiding the flow of passersby, and welcoming people to stop and interact, Backdrop flows with an environment's existing features and inspires the lives of the people who engage with it. Placed along people's daily paths—such as throughout streetscapes, corporate, university and healthcare campuses, residential communities, and hospitality and retail venues—Backdrop creates sought-out places for focus and productivity, a bite to eat, an impromptu conversation, or a personal moment to recharge.

This Planning Guide offers ideas and inspiration on how Backdrop can be applied in these diverse contexts, illustrating how its structural modularity, dynamic functionality, and varied accessories can bring new value to existing and underutilized outdoor spaces. As Backdrop is designed and engineered to spark designers' creativity and empower them to craft unique, site-specific installations, the following examples represent only a small fraction of the potential solutions this adaptable system offers.

Panels

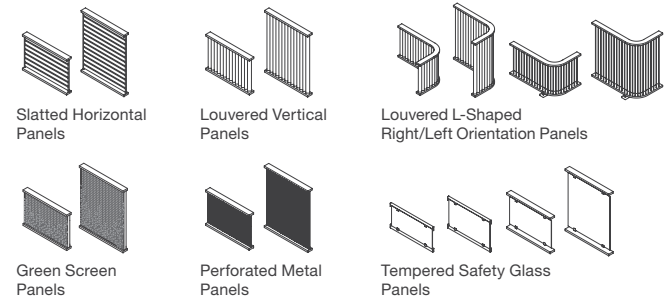

Accessories

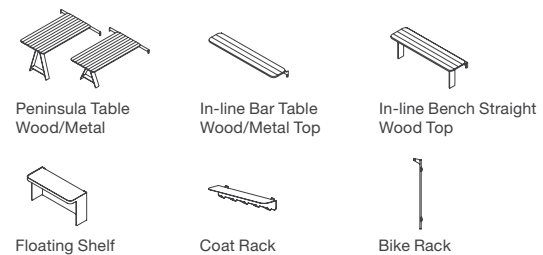

Posts

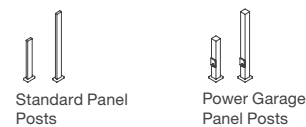

Connectors



01 Live – Streetscapes	
a. Mixed Use	04
b. Linear Park	12
02 Learn – School Campuses	
a. Plaza	19
b. Study Space	26
03 Work – Corporate Campuses	
a. Meeting Space	34
b. Workshop	41
04 Care – Healthcare Campuses	
a. Respite	48
b. Viewing Garden	54
05 Play – Hospitality	
a. Dining Parklet	61
b. Resort	68
06 Shop – Retail	
a. Mixed Use	75
b. Plaza	82

01

Live – Streetscapes

a. Mixed Use













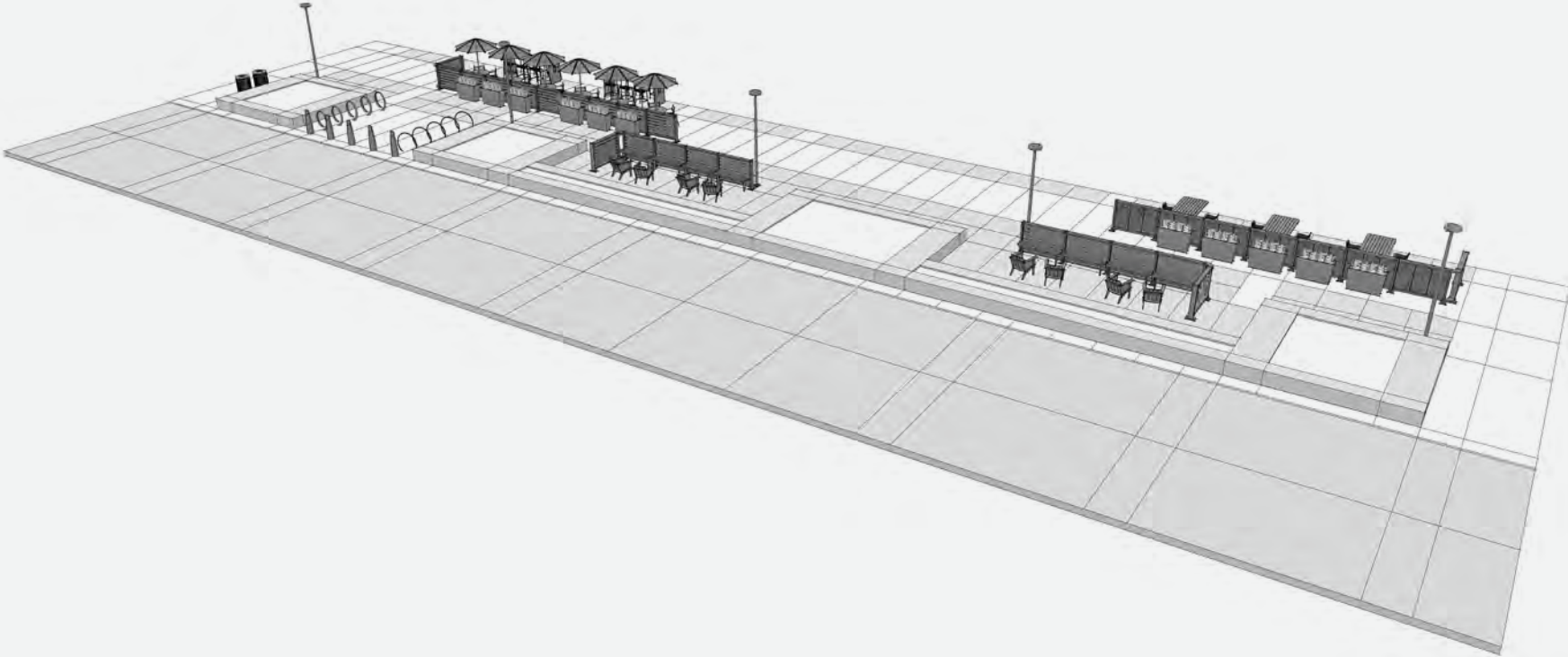

01

Live – Streetscapes

b. Linear Park

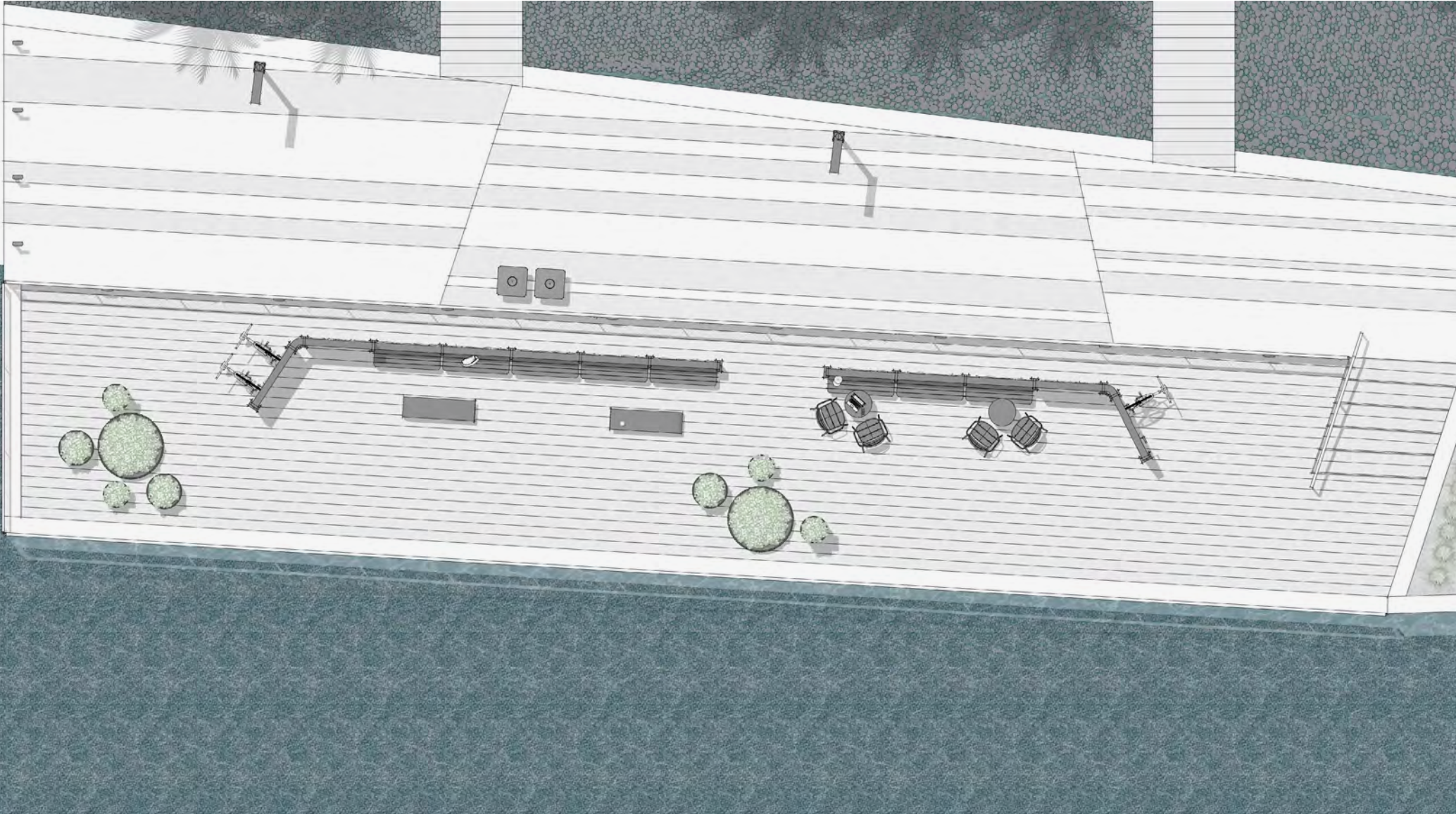









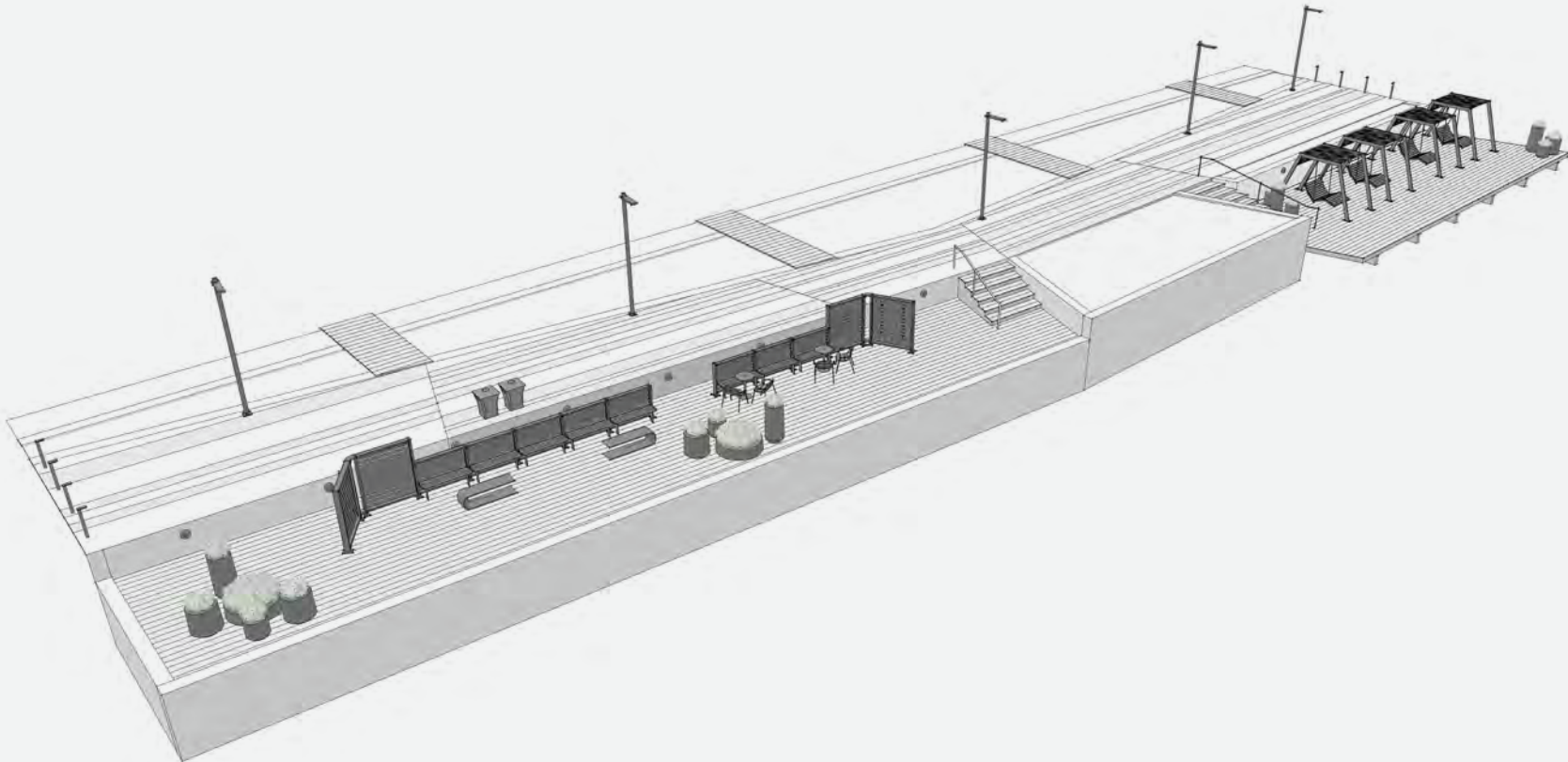

02

Learn – School Campus

a. Plaza

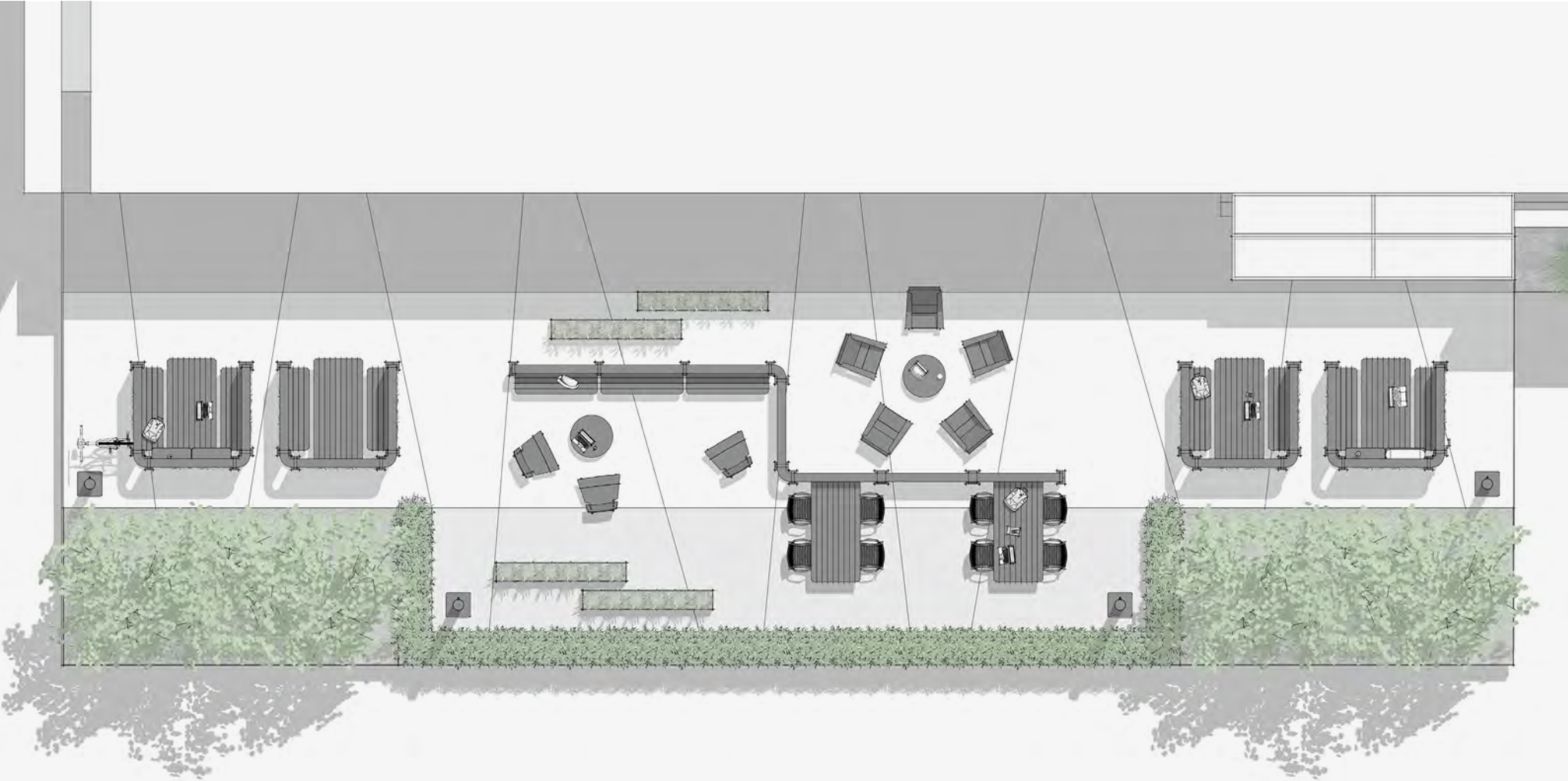









Plaza | Learn – School Campus

[Back to Index](#)

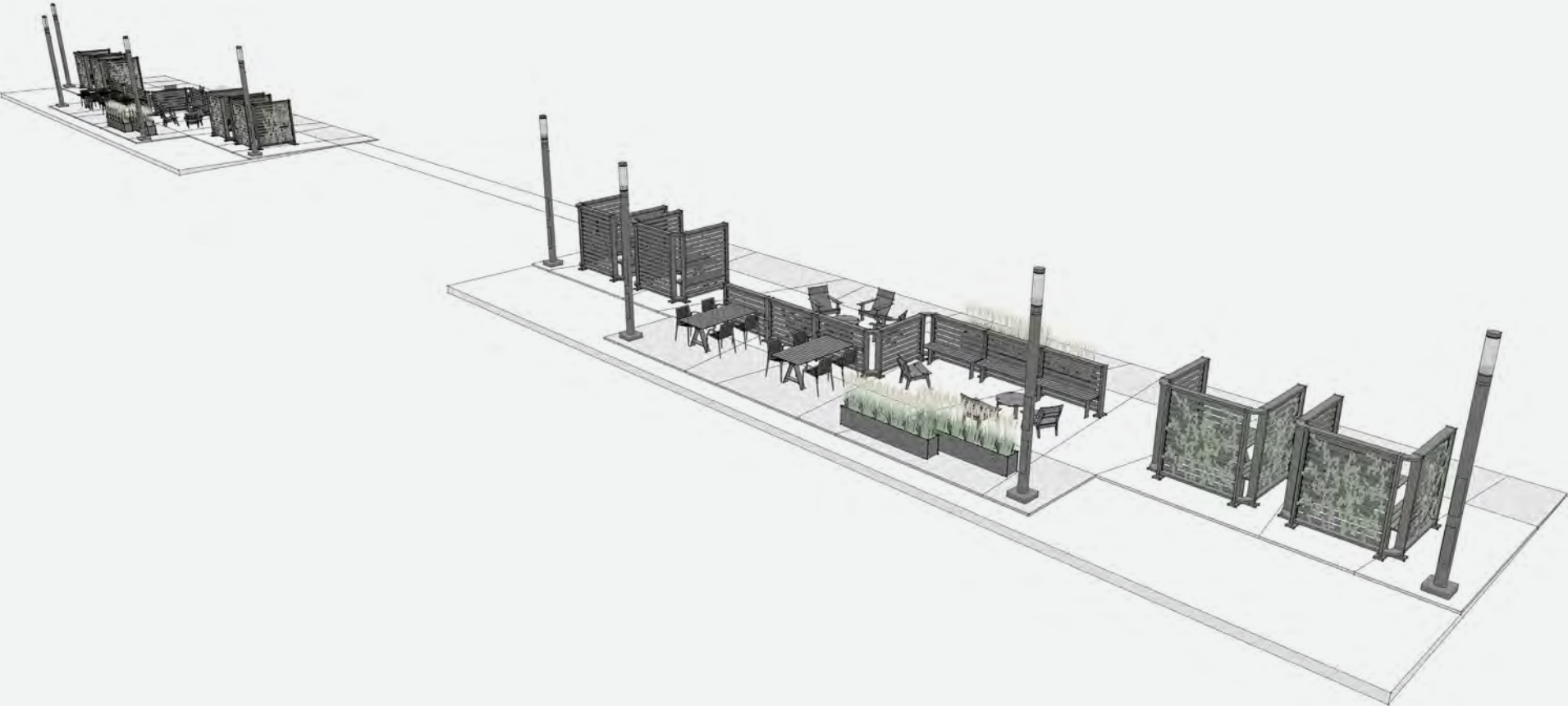

02

Learn – School Campus
b. Study Space

Study Space | Learn – School Campus

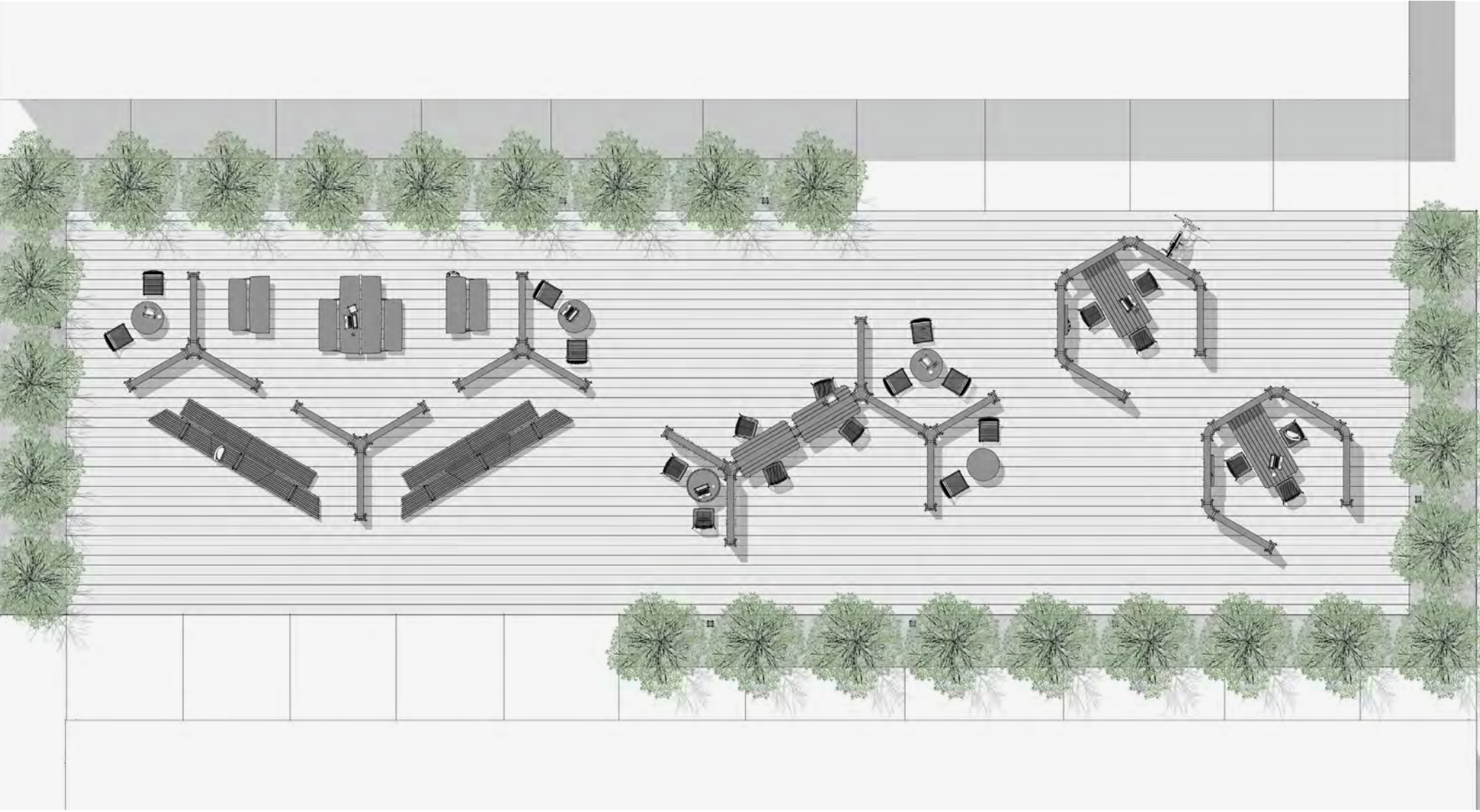

Study Space | Learn – School Campus











Study Space | Learn – School Campus

[Back to Index](#)

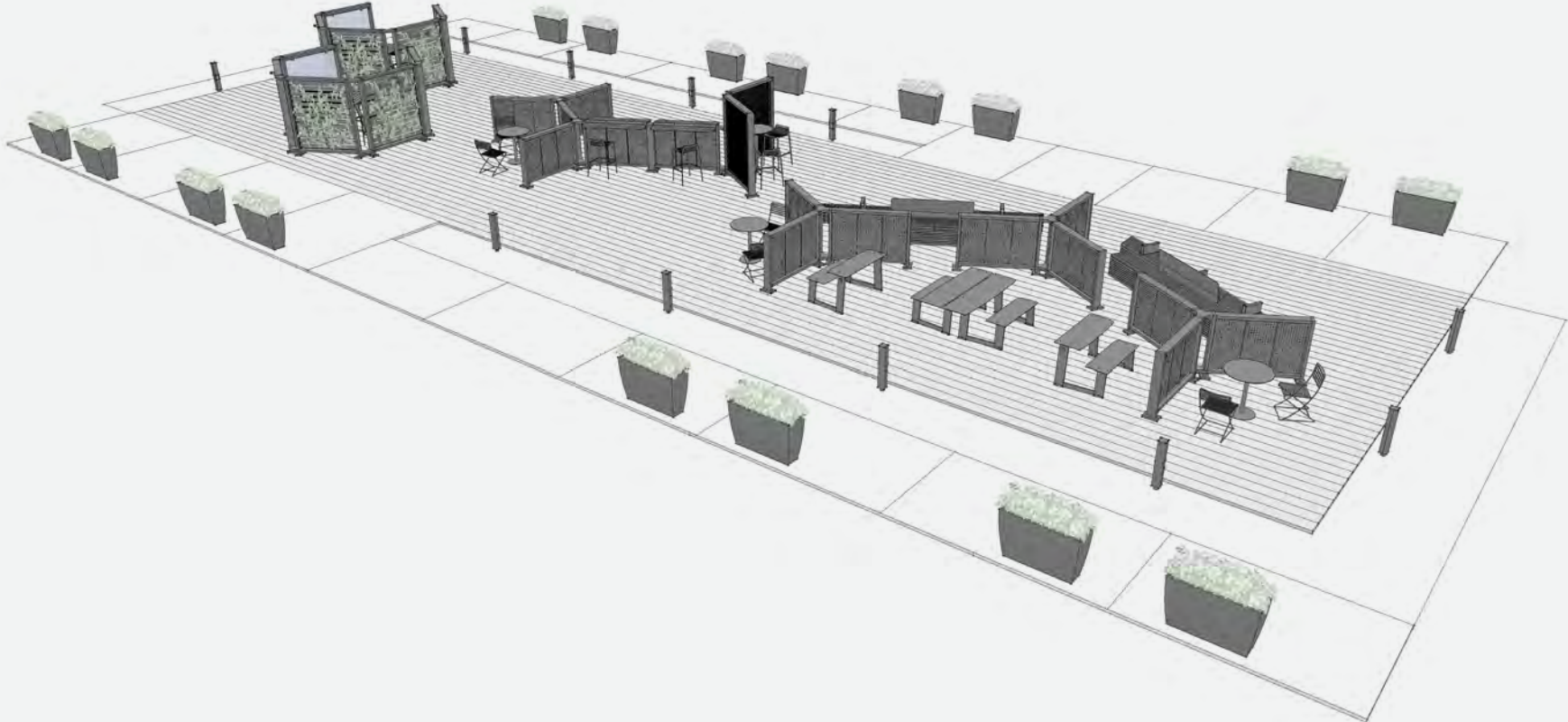

03

Work – Corporate Campus
a. Meeting Space

Meeting Space | Work – Corporate Campus











Meeting Space | Work – Corporate Campus

[Back to Index](#)

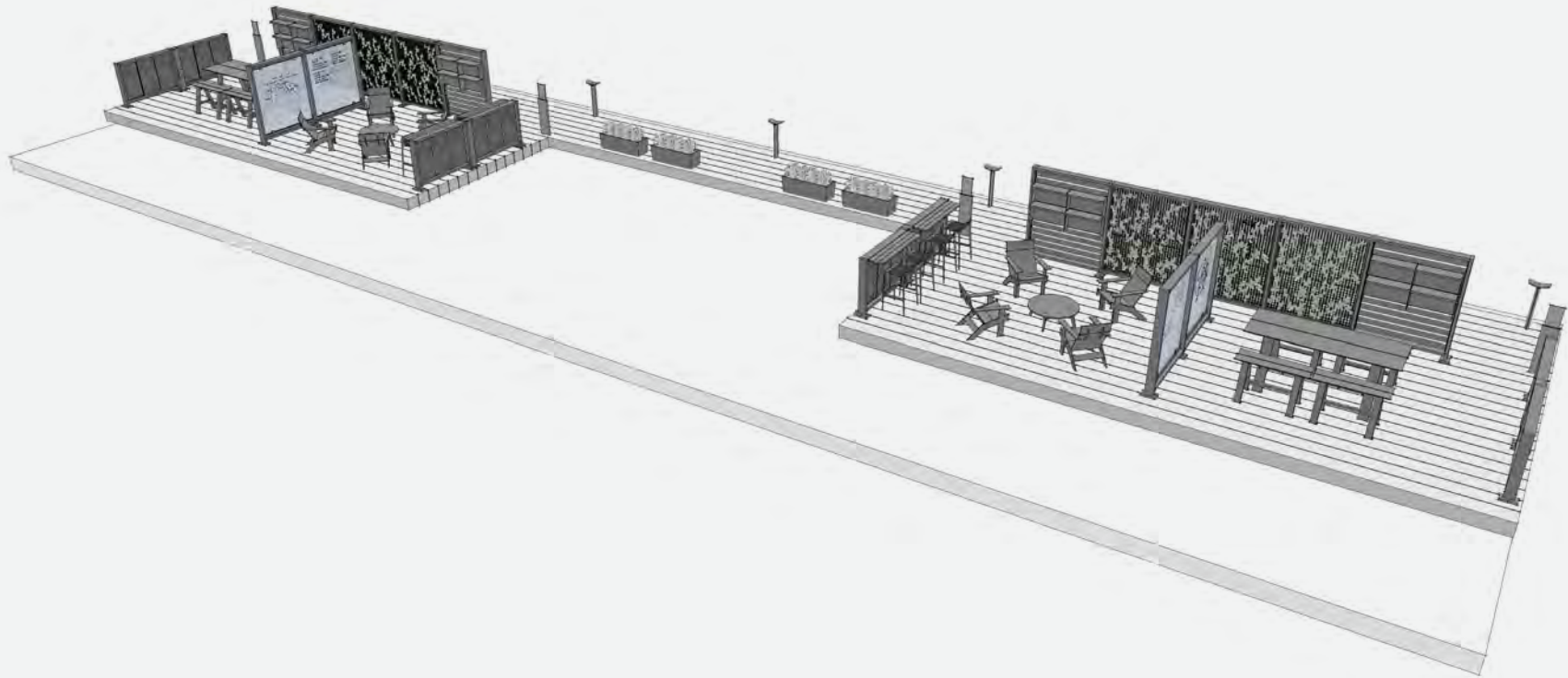

03

Work – Corporate Campus

b. Workshop

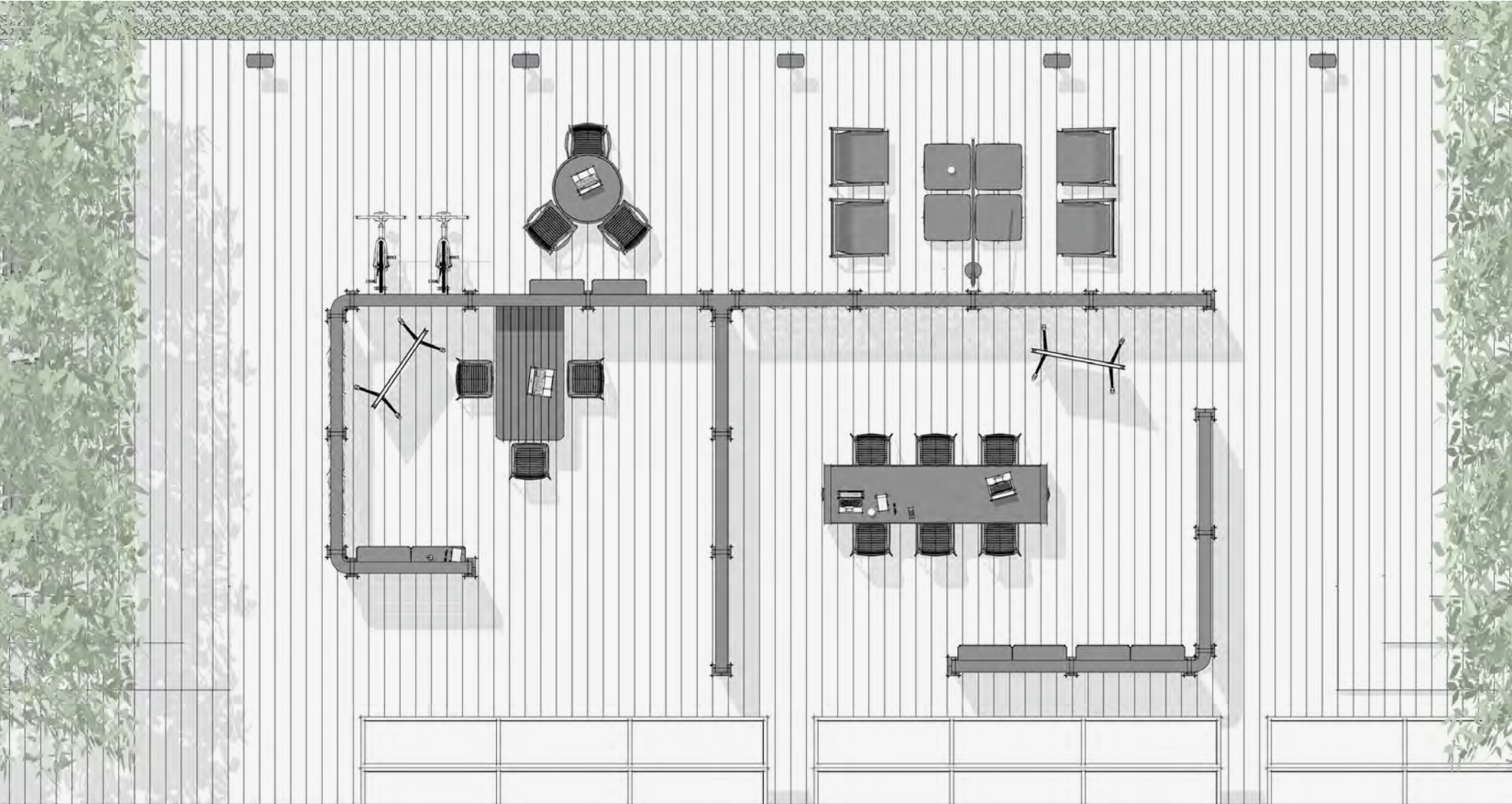











04

Care – Healthcare Campus

a. Respite

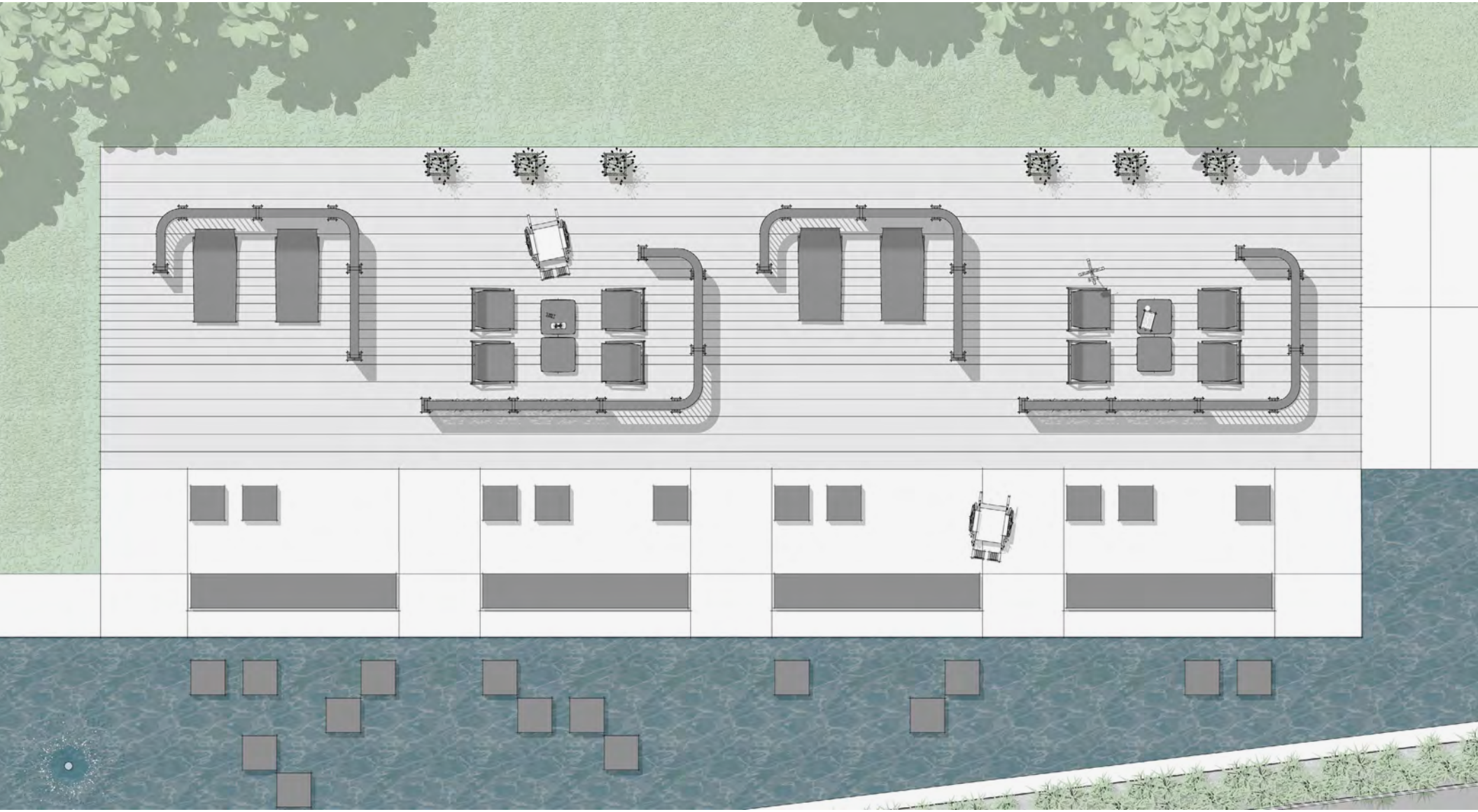







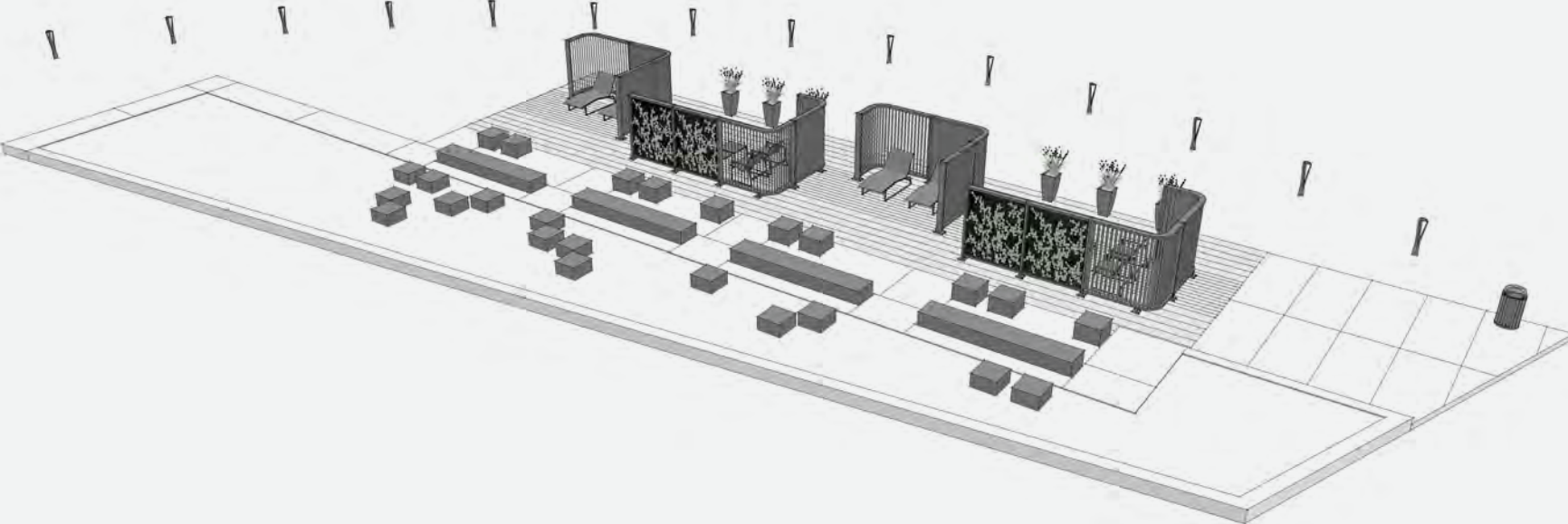

04

Care – Healthcare Campus
b. Viewing Garden

Viewing Garden | Care – Healthcare Campus

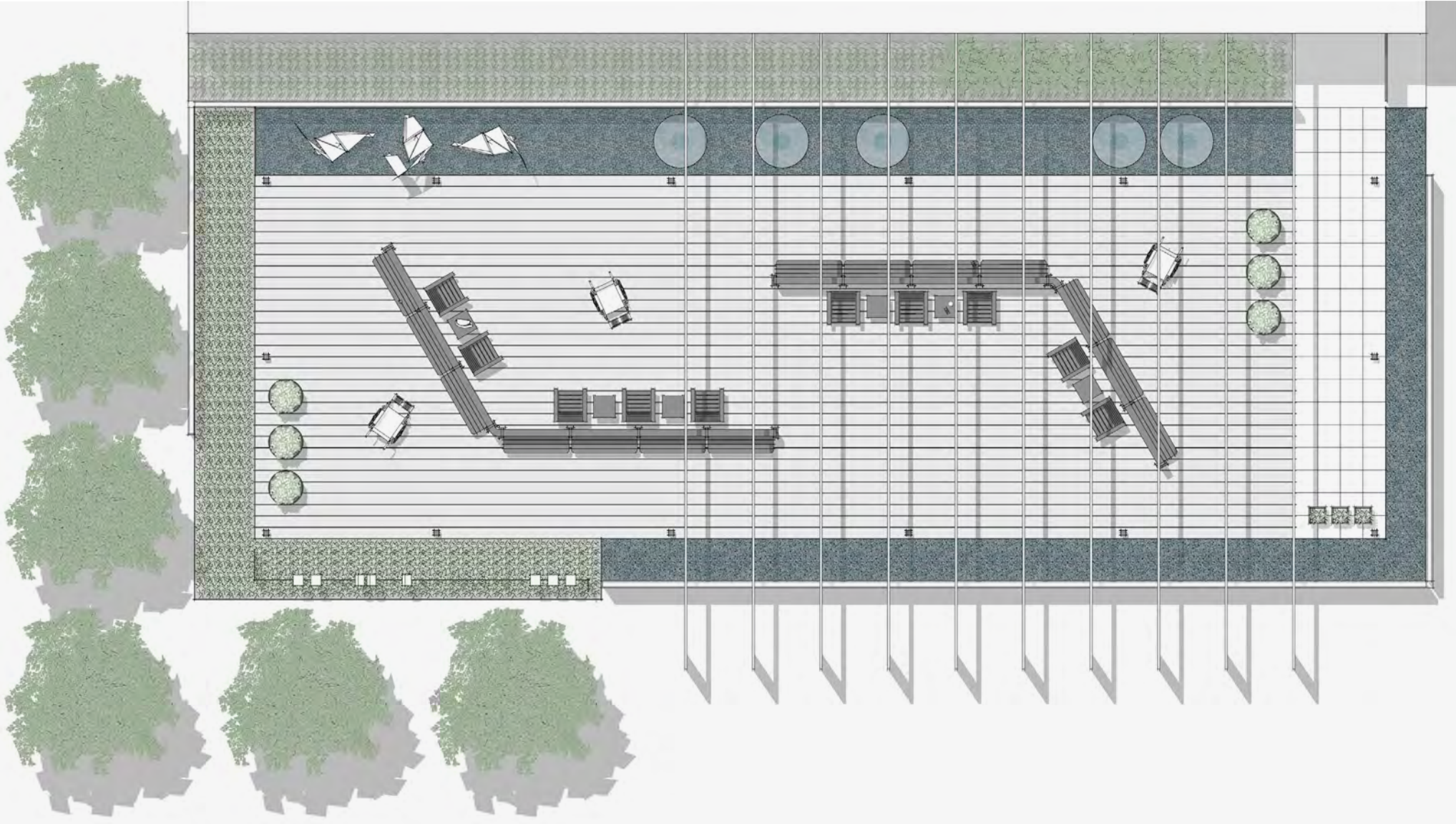



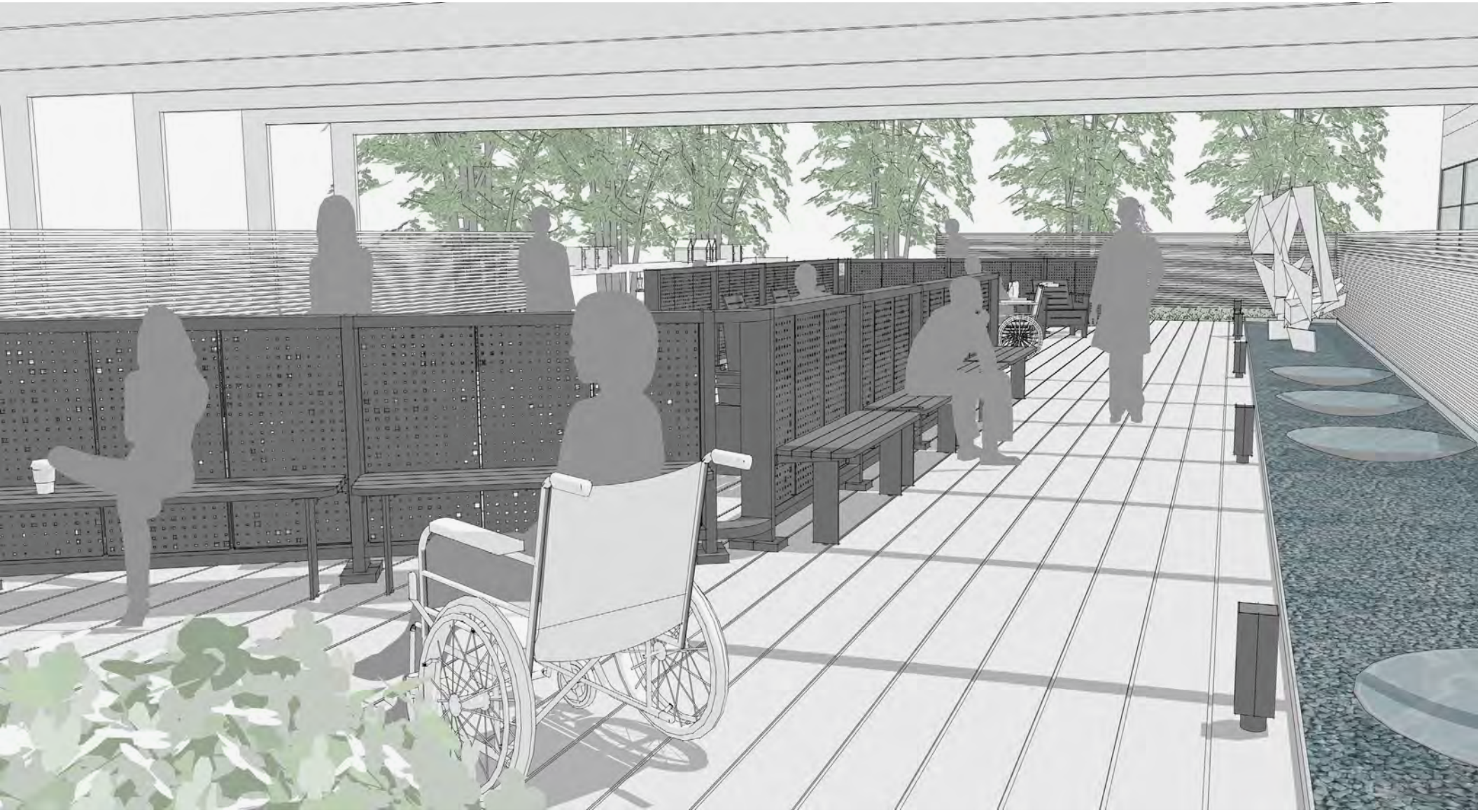

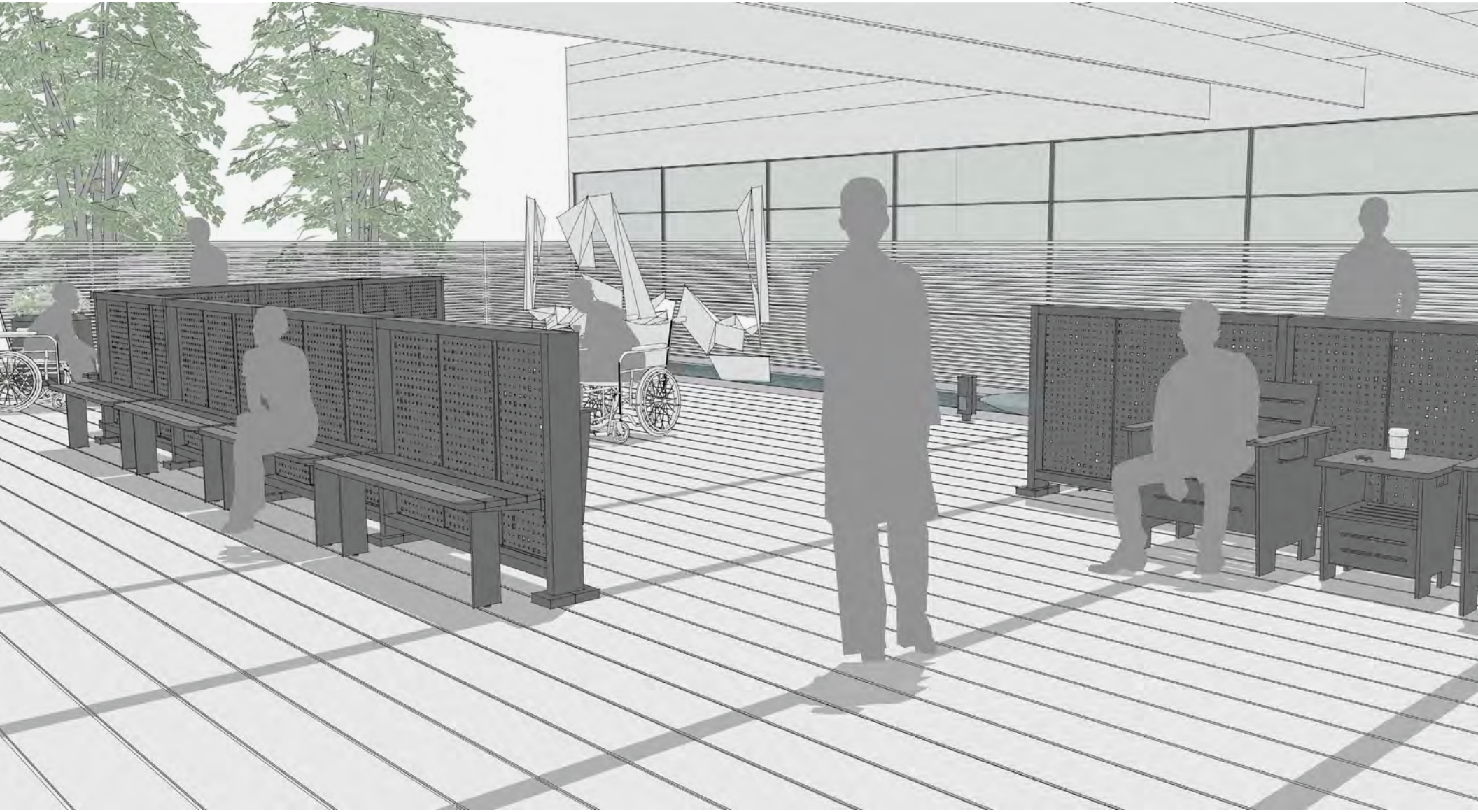



Viewing Garden | Care – Healthcare Campus

[Back to Index](#)

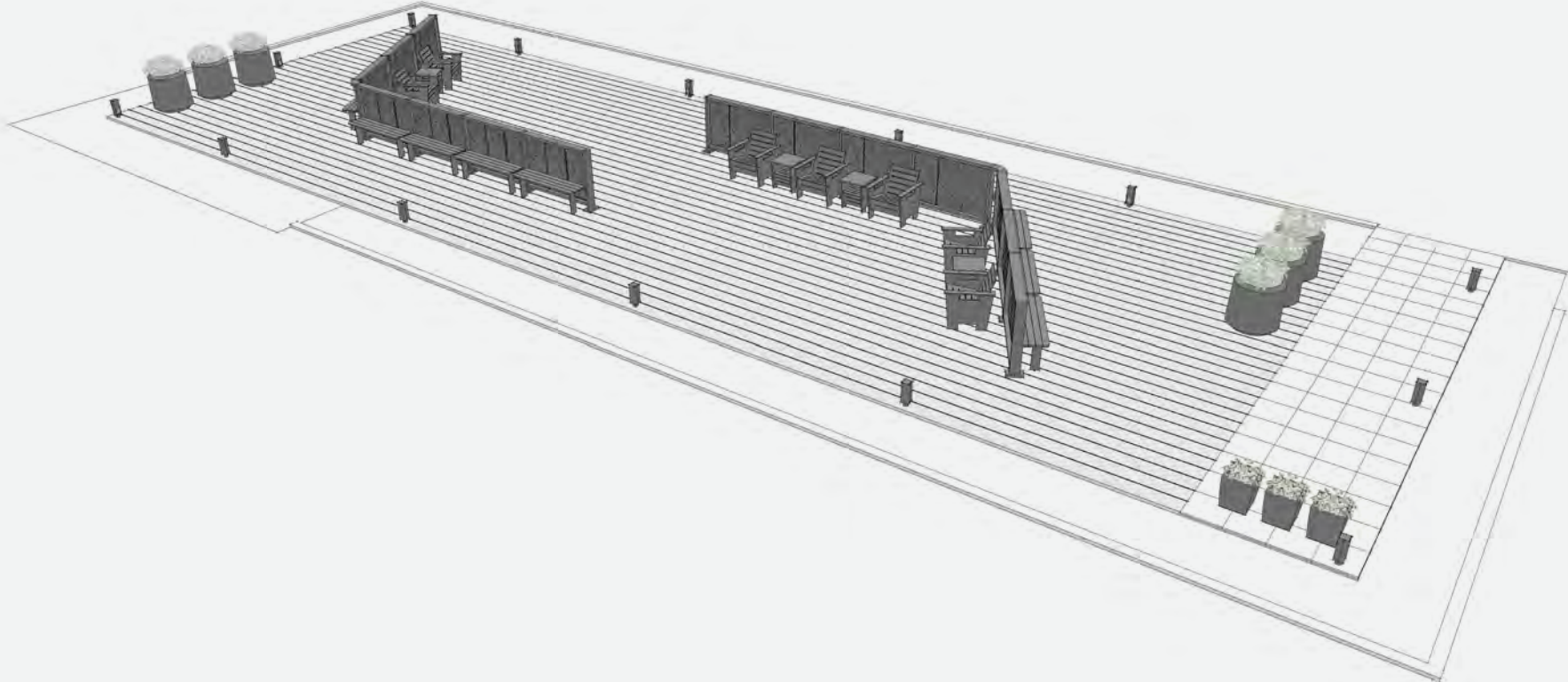

05

Play – Hospitality
a. Dining Parklet

Dining Parklet | Play – Hospitality

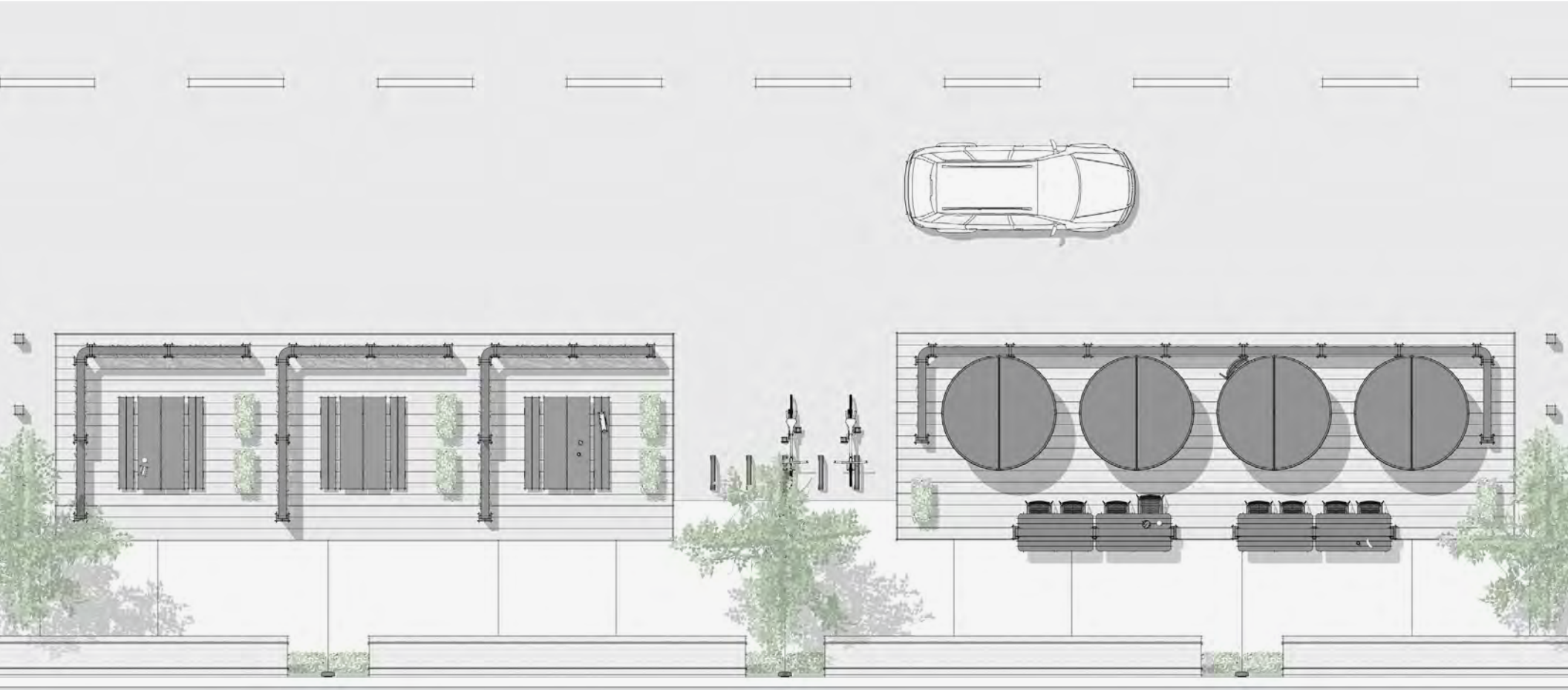

Dining Parklet | Play – Hospitality









Dining Parklet | Play – Hospitality

[Back to Index](#)

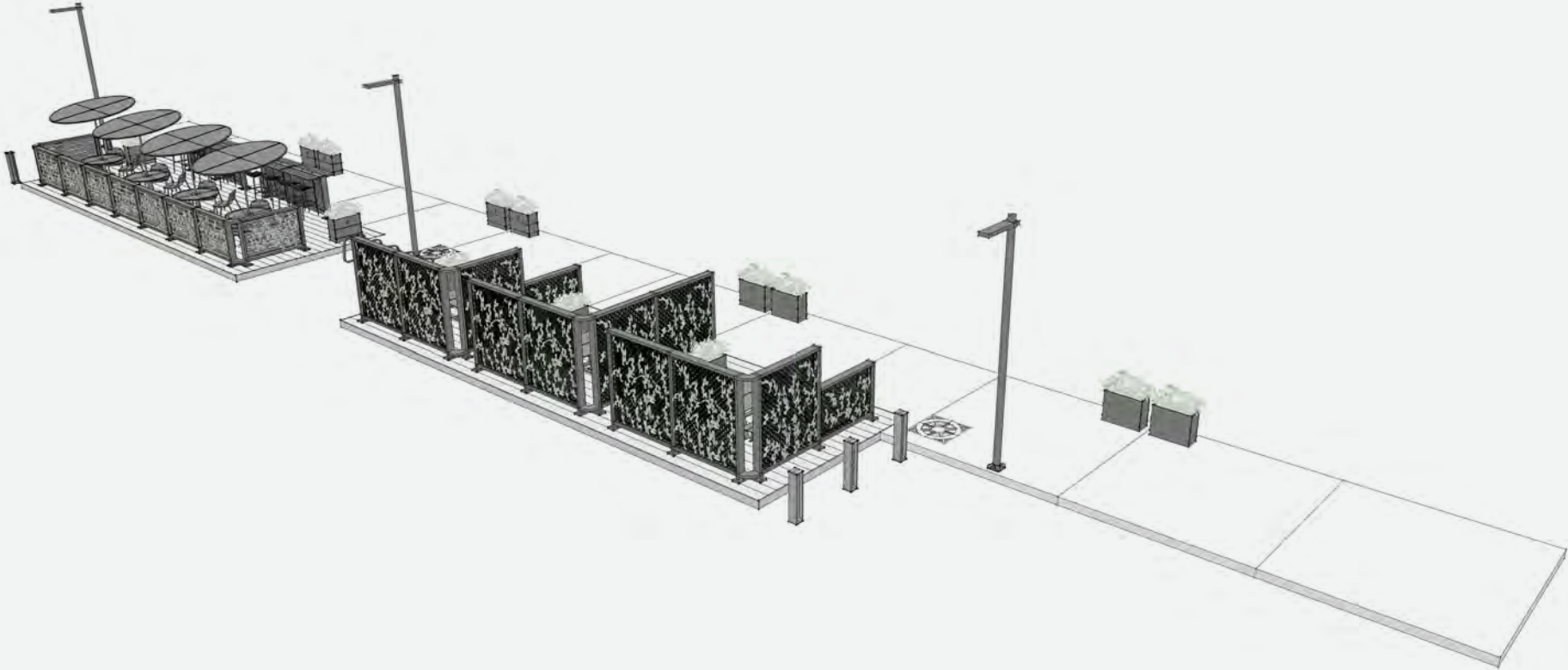

05

Play – Hospitality

b. Resort

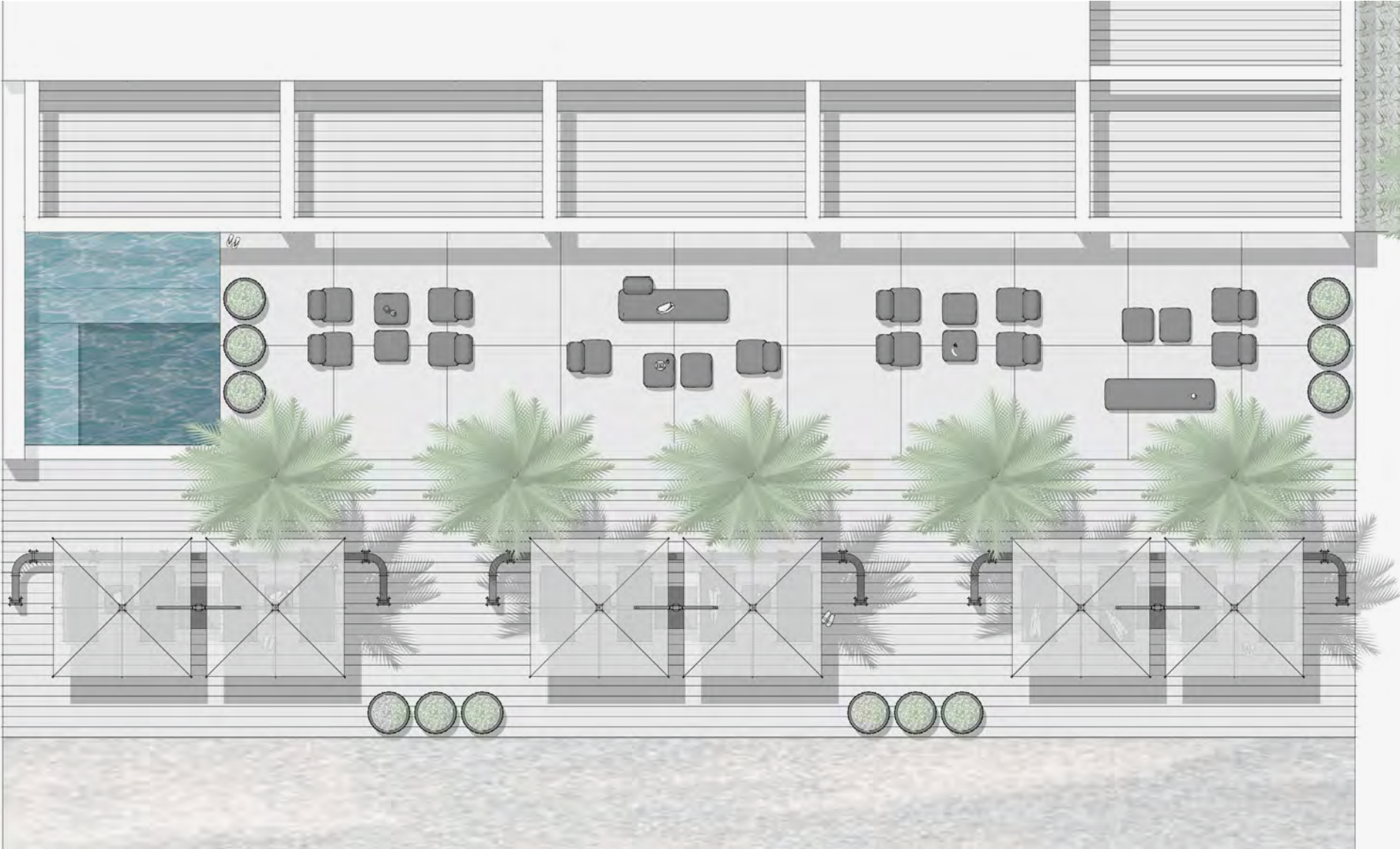









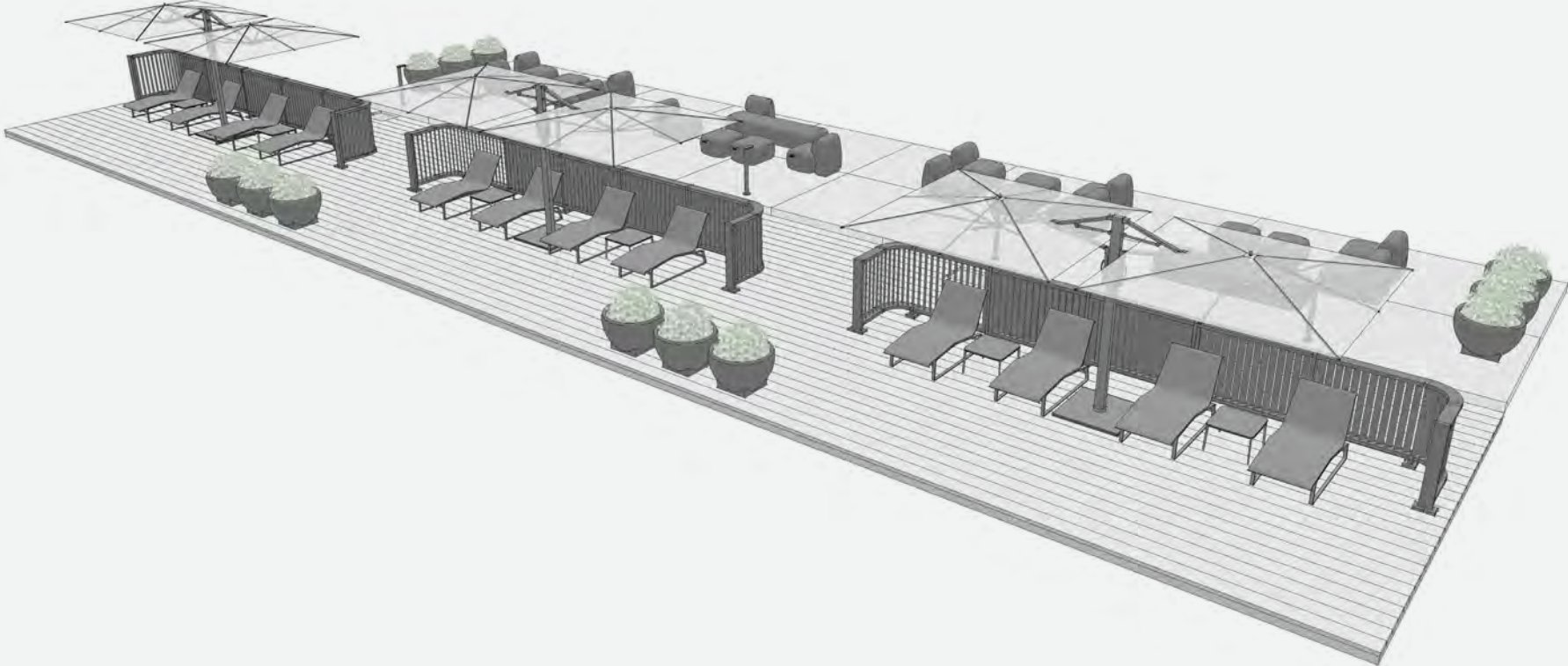

06

Shop – Retail

a. Mixed Use











Mixed Use | Shop – Retail

[Back to Index](#)

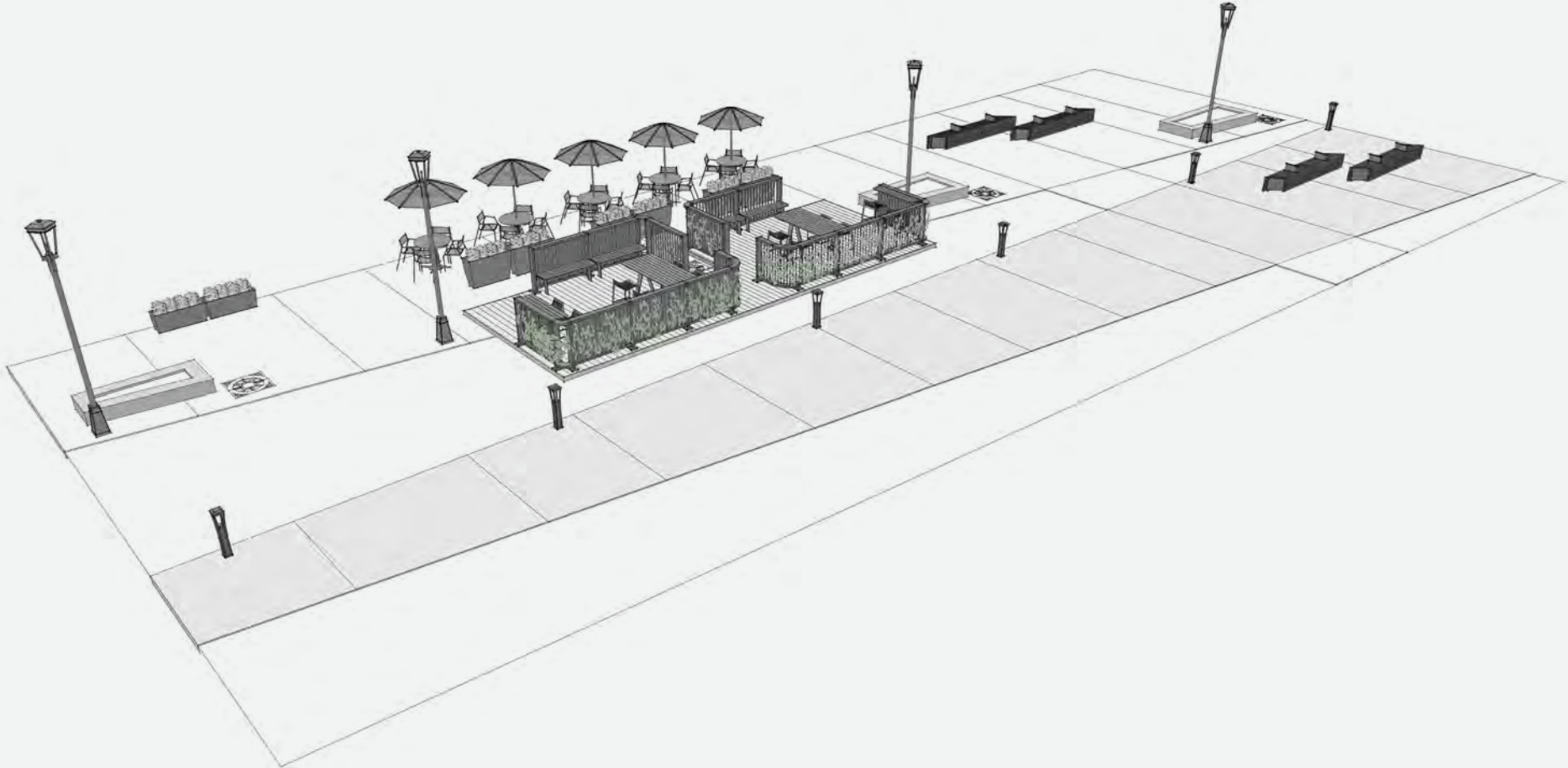

06

Shop – Retail

b. Plaza

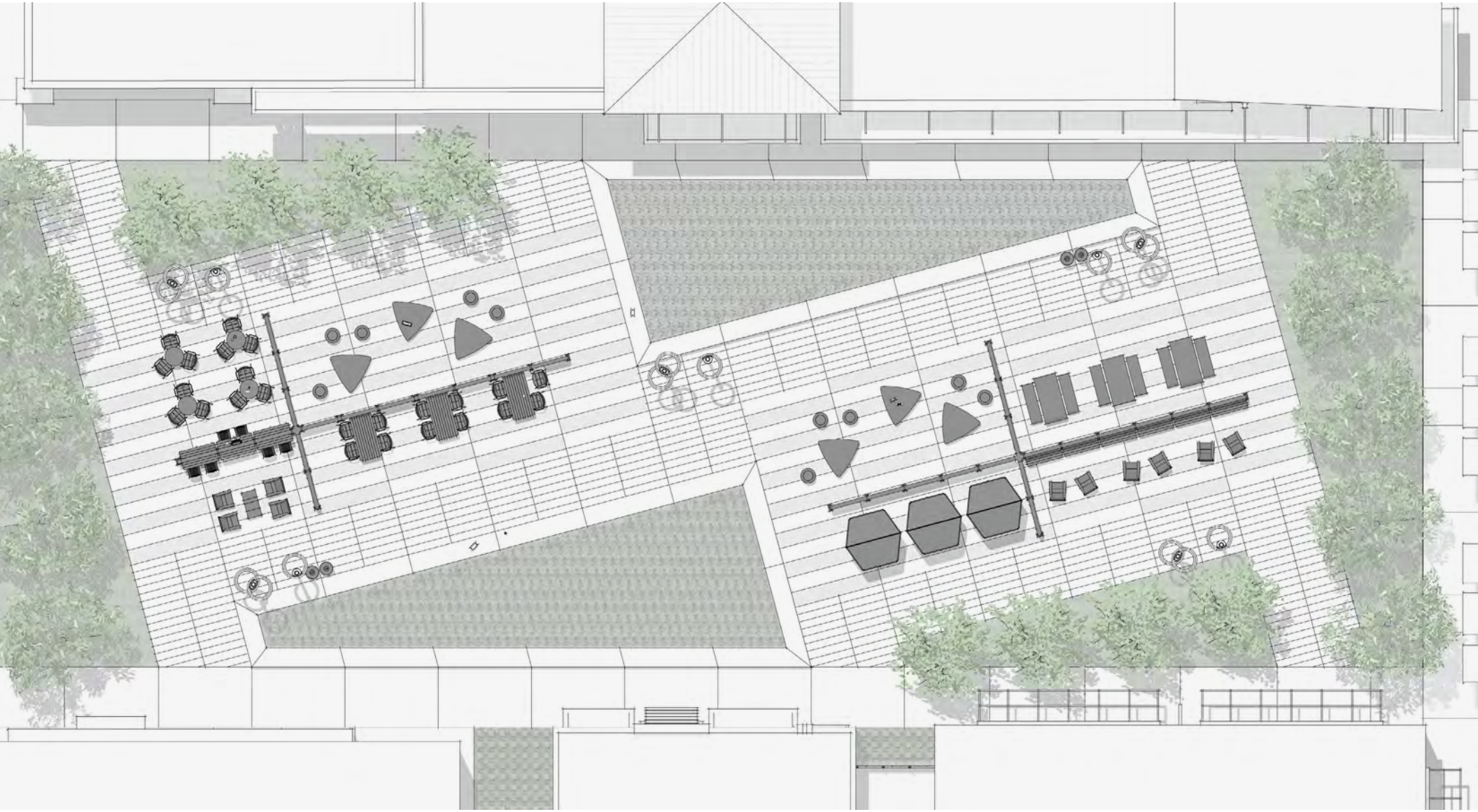









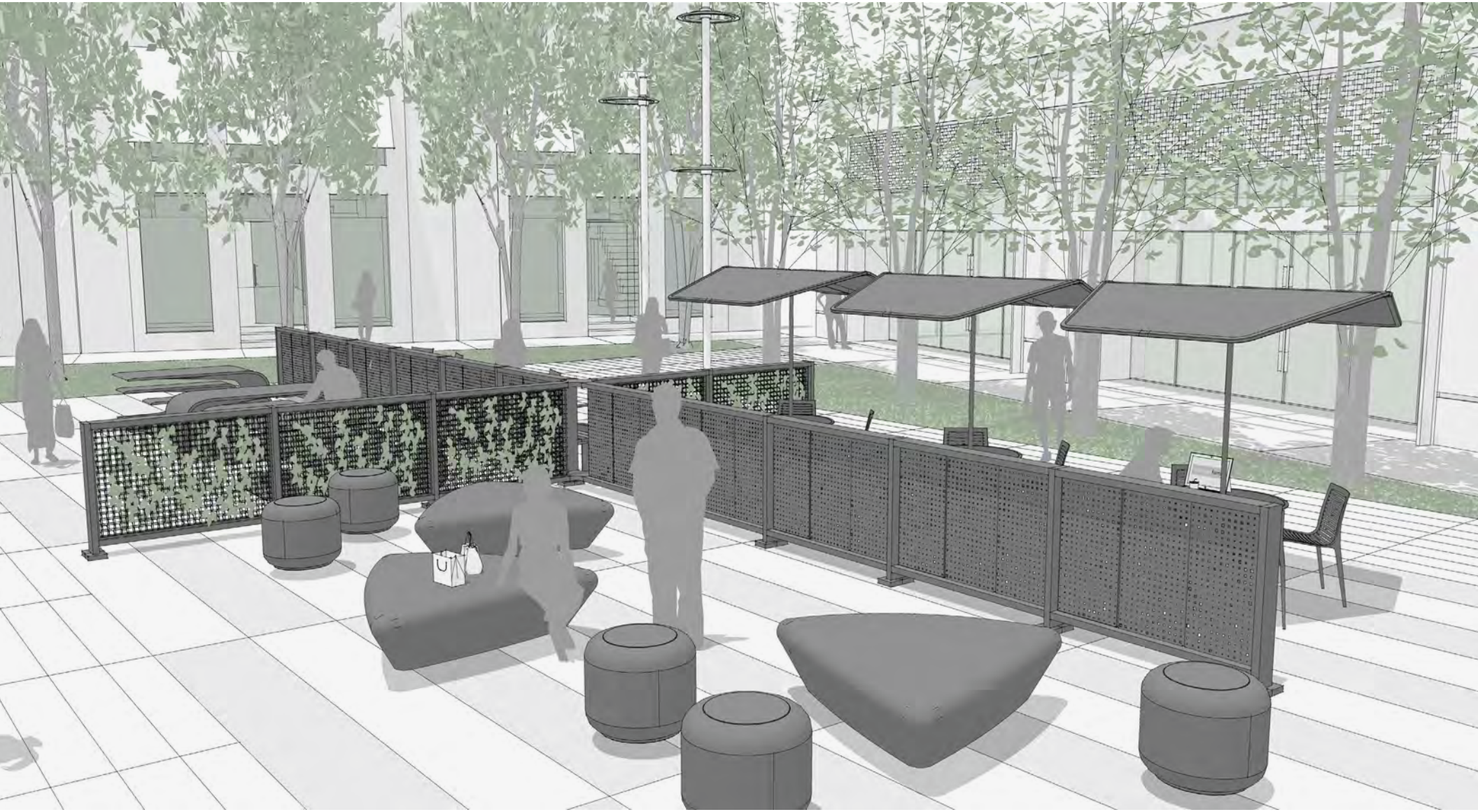

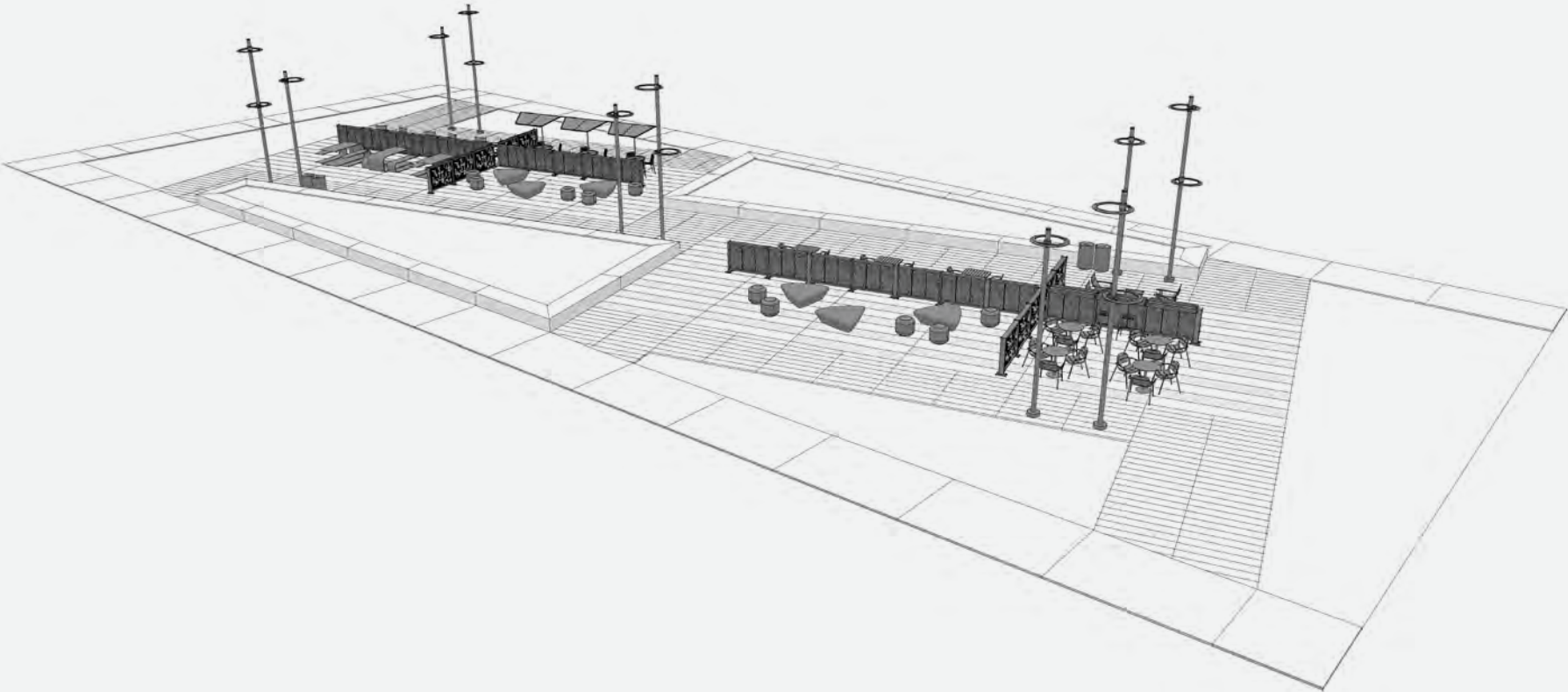

landscapeforms.com/backdrop

Backdrop: Design by Landscape Forms in Collaboration with KEM STUDIO

Specifications are subject to change without notice. Landscape Forms supports the Landscape Architecture Foundation at the Second Century level.
©2022 Landscape Forms, Inc.

